

# AlphaSorb® Polyester Core Acoustic Panel

## Covers These Methods Of Mounting Rotofast Polyester Snap-On Anchor | Z-Clips

These installation instructions are given as a general guide to avoid common errors. Installer should follow best practices for construction and workmanship. Acoustical Solutions bears no responsibility for installation or contractor selection. Please contact a sales representative if you have questions, concerns or specific project requirements.

Be sure to inspect materials upon delivery. Please note any damage on the delivery ticket and notify Acoustical Solutions immediately. Materials should be stored in original packing in a clean, climate controlled environment free of moisture. Installation should not commence until building is enclosed and under standard occupancy conditions and surfaces are of acceptable condition and properly prepared. Do not install materials of unacceptable quality.

All fabrics except FR701 are directional meaning they have visible pattern directionality. Fabric directionality must be considered when determining fabric wrapped acoustical product orientation to maintain a consistent pattern flow. If you need help with design and panel orientation, please contact a sales consultant for assistance.

### Recommended safety precautions:

- Wear safety glasses
- Wear black nitrile gloves to avoid getting fingerprints on the panels
- Wear long sleeves to protect from fiberglass fibers
- We recommend two or more people to install panels that are 4' x 4' or larger
- Follow the safety guidelines of any equipment being used (power tools, ladders, etc.)
- Follow OSHA guidelines when applicable

Revised: 2025-08-12

# AlphaSorb® Polyester Core Acoustic Panel

## Rotofast Polyester Snap-On

Recommended anchor locations and quantities per panels are on the following pages.



Measure and mark the location where panel will be placed and mark the orientation on the back of the panel.



Make a cut about 1½" long by ¾" deep at each anchor location. It may take a few passes to complete the cut.



Screw Rotofast Polyester Snap-On Anchors into back of the panel using the Rotofast driver tool. Do not over-tighten.

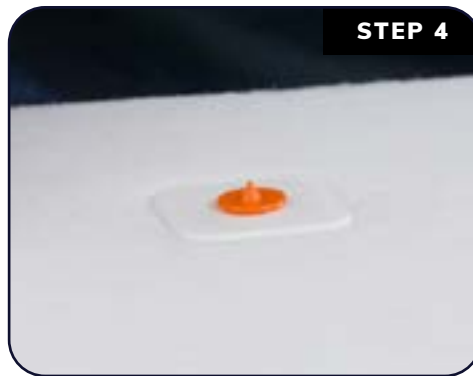

Insert reusable marking plugs into the Snap-On anchors.



Push panel against wall to mark anchor locations.

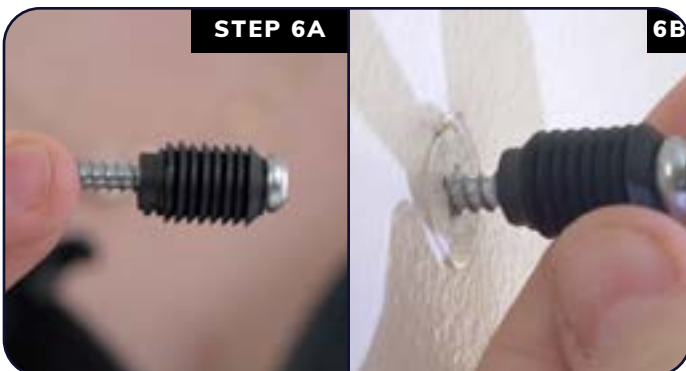

Screw ratchets to wall at marked locations. Flat end of ratchet goes against the wall; curved end faces out.

**#8 screws recommended; hollow wall anchors are recommended for drywall applications.**

Revised: 2025-08-12

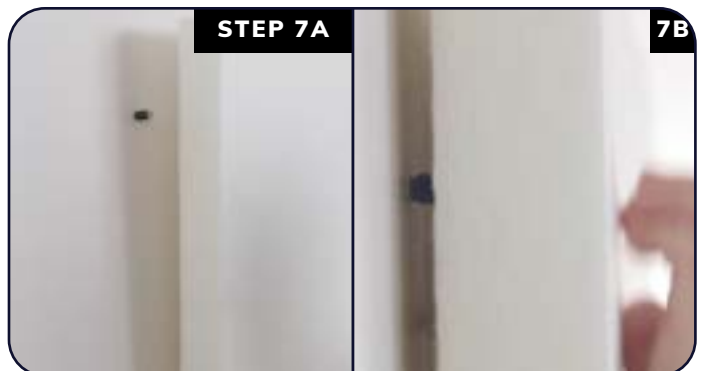

Firmly strike panel onto ratchets to complete the installation.

# AlphaSorb® Polyester Core Acoustic Panel

## Rotofast Anchors

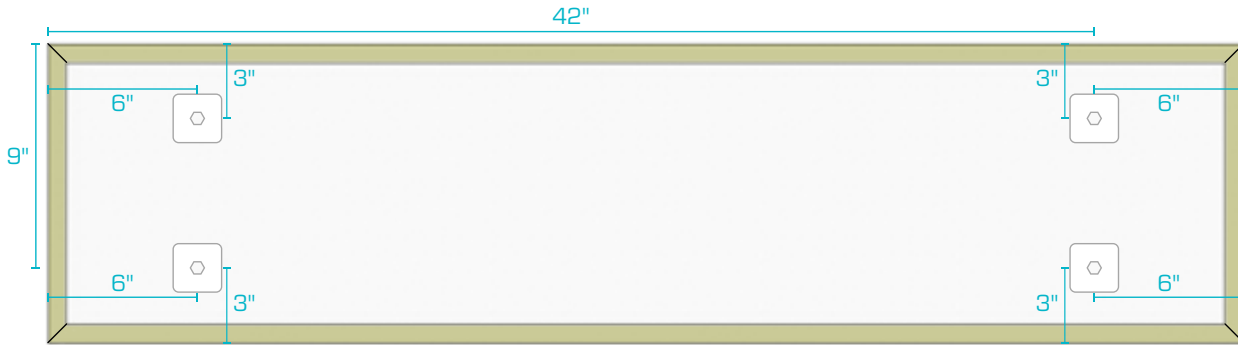

**1' x 4' Panel**

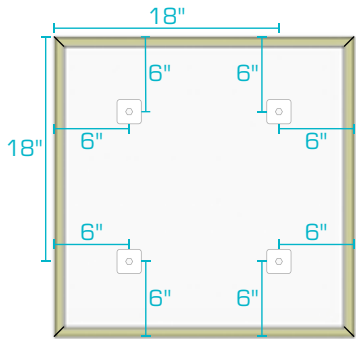

**2' x 2' Panel**

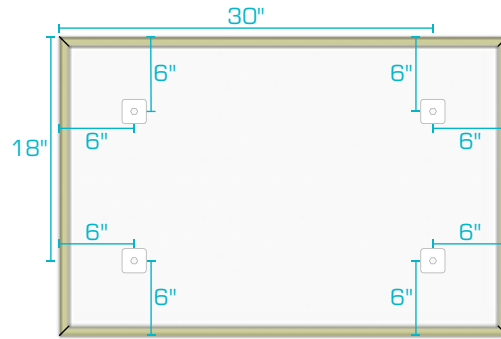

**2' x 3' Panel**

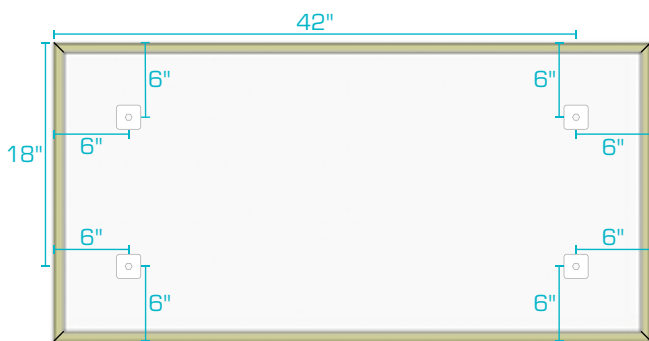

**2' x 4' Panel**

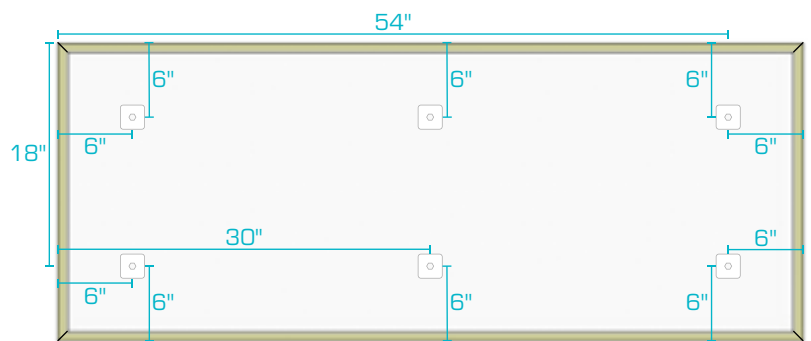

**2' x 5' Panel**

Revised: 2025-08-12

# AlphaSorb® Polyester Core Acoustic Panel

## Rotofast Anchors

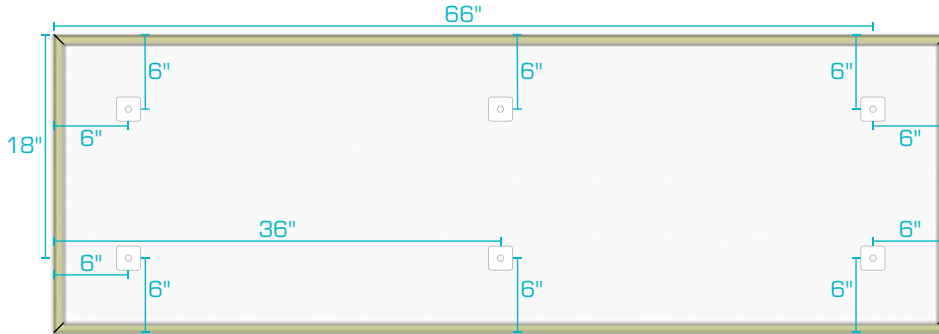

**2' x 6' Panel**

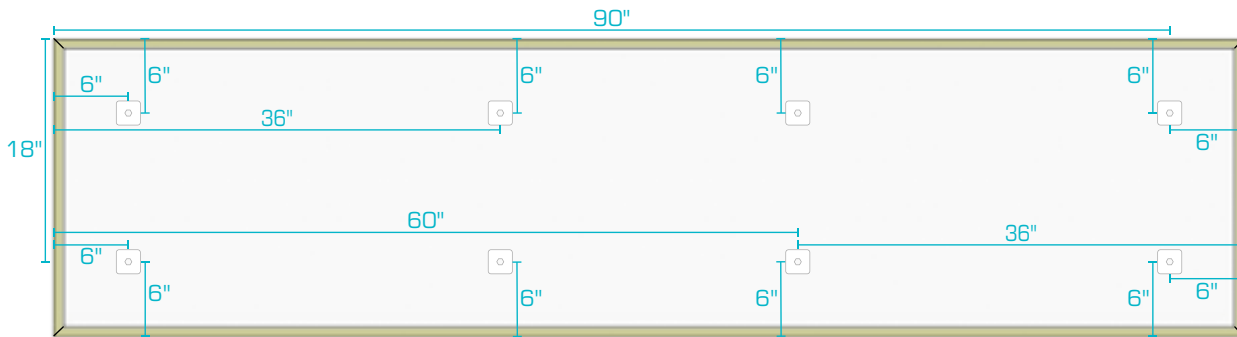

**2' x 8' Panel**

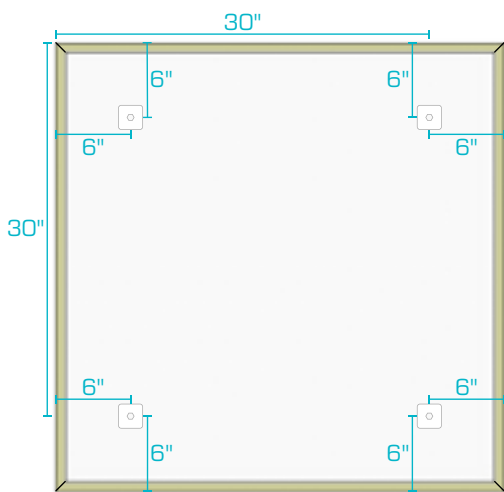

**3' x 3' Panel**

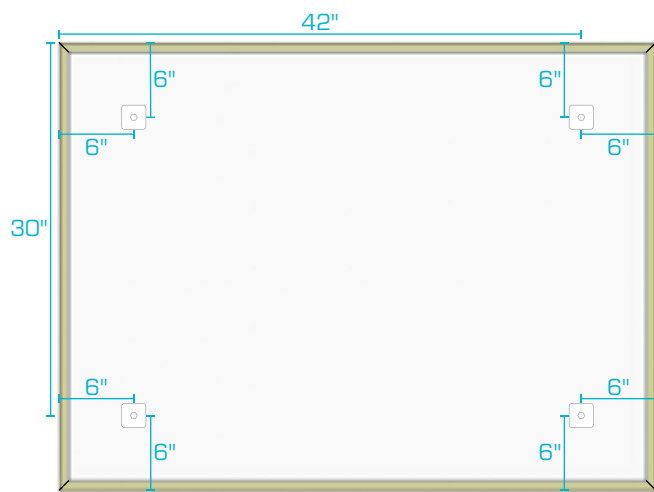

**3' x 4' Panel**

Revised: 2025-08-12

# AlphaSorb® Polyester Core Acoustic Panel

## Rotofast Anchors

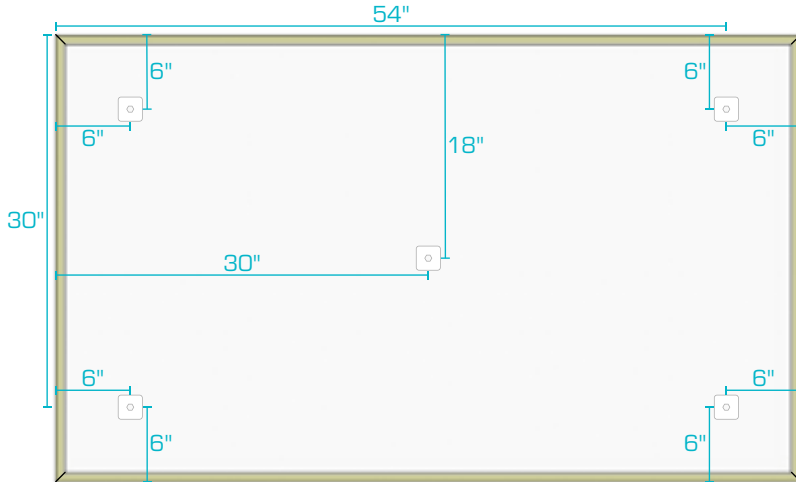

**3' x 5' Panel**

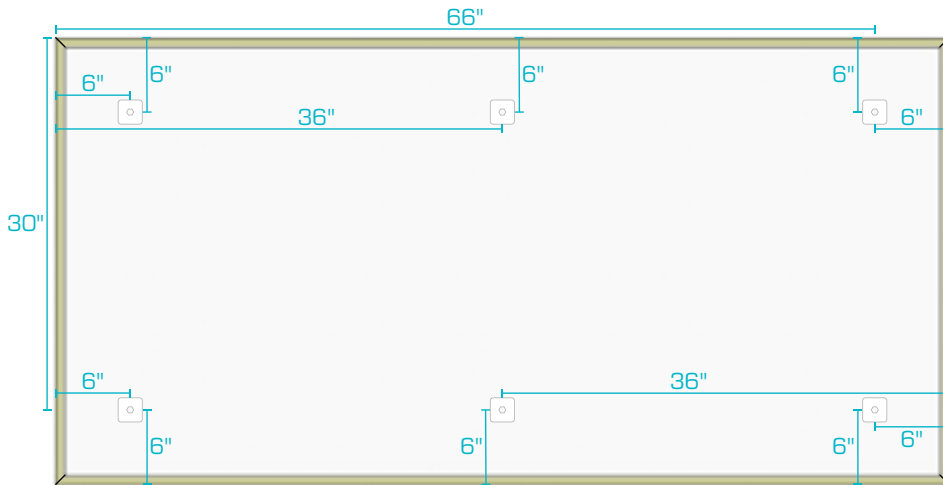

**3' x 6' Panel**

Revised: 2025-08-12

# AlphaSorb® Polyester Core Acoustic Panel

## Rotofast Anchors

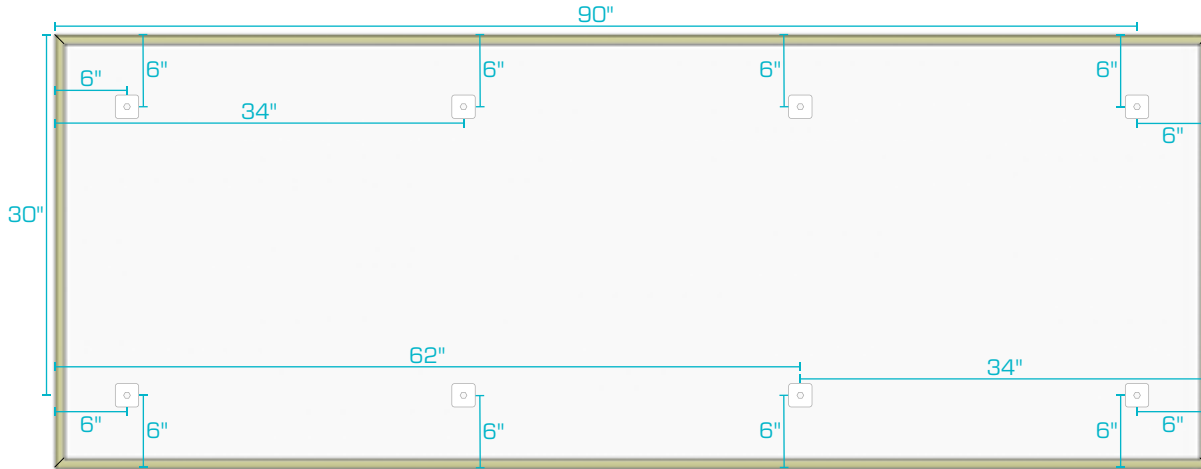

**3' x 8' Panel**

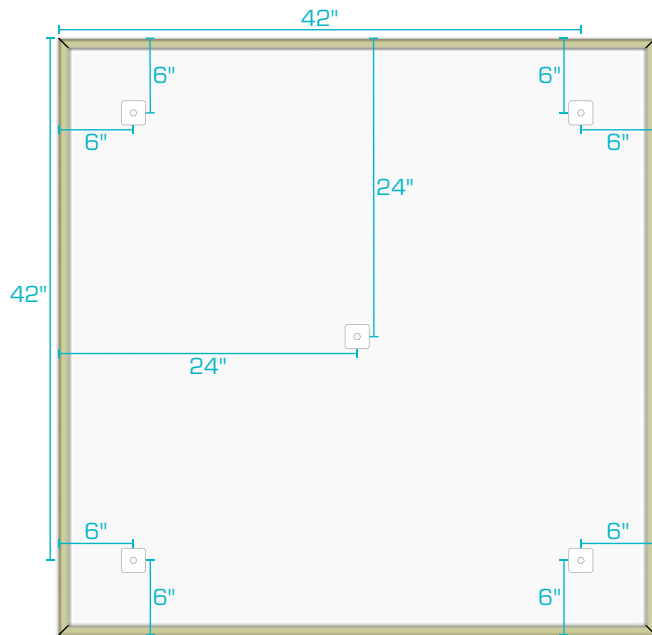

**4' x 4' Panel**

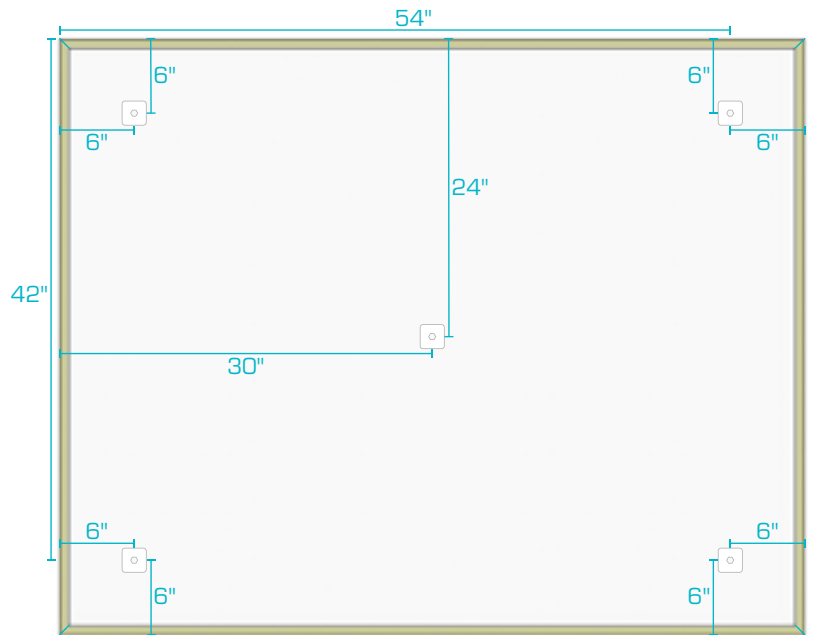

**4' x 5' Panel**

Revised: 2025-08-12

# AlphaSorb® Polyester Core Acoustic Panel

## Rotofast Anchors

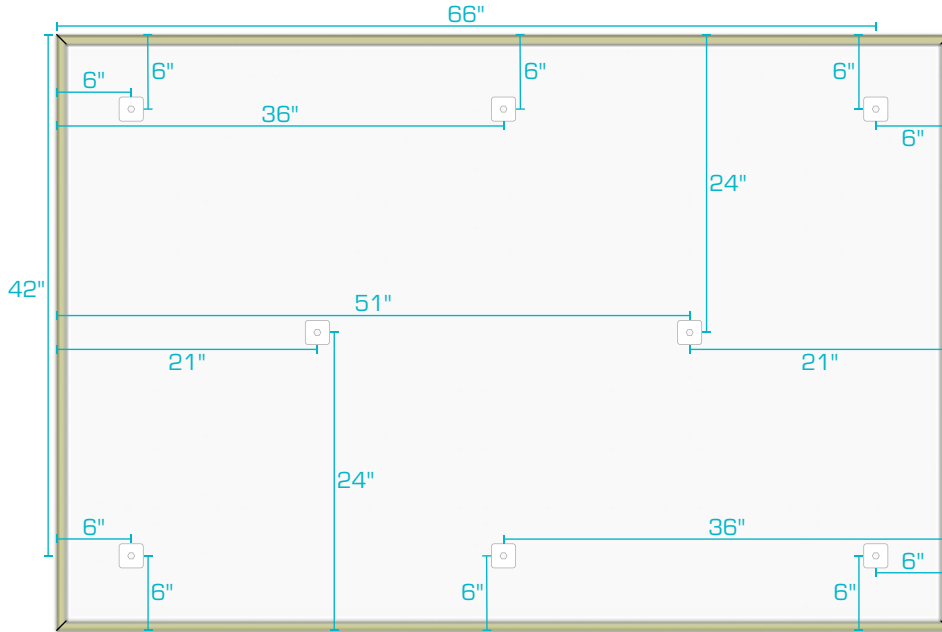

**4' x 6' Panel**

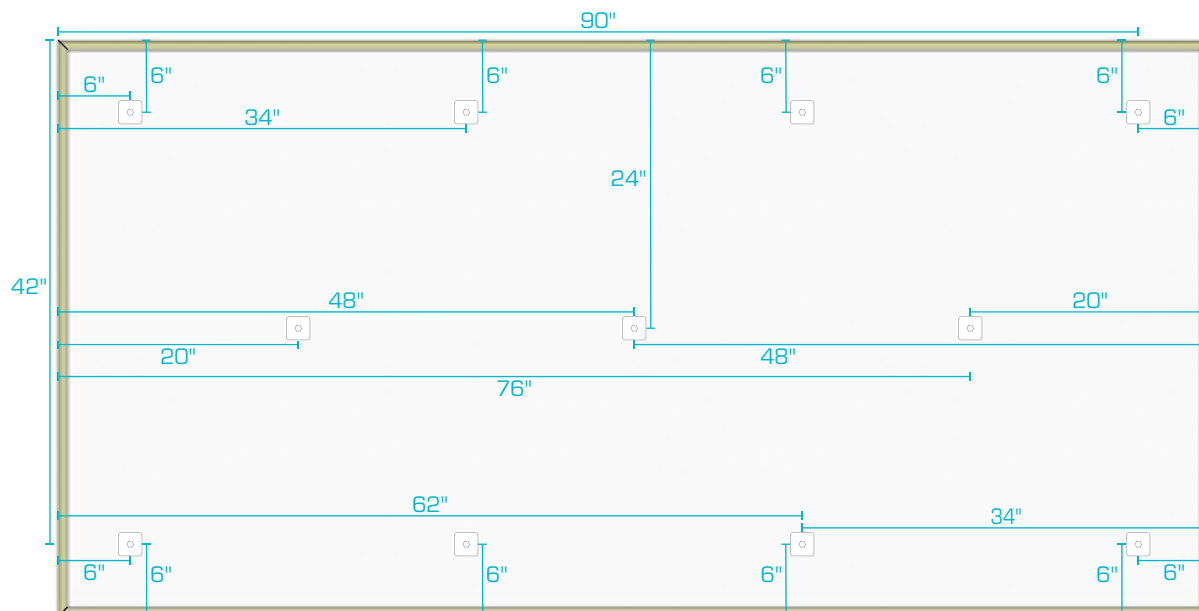

**4' x 8' Panel**

Revised: 2025-08-12

# AlphaSorb® Polyester Core Acoustic Panel

## Z-Clips



Measure and mark the location where panel will be placed and mark the orientation on the back of the panel.



Make a cut about 1½" long by ¾" deep at each anchor location. It may take a few passes to complete the cut.



Screw Rotofast Polyester Snap-On Anchors into back of the panel using the Rotofast driver tool. Do not over-tighten.

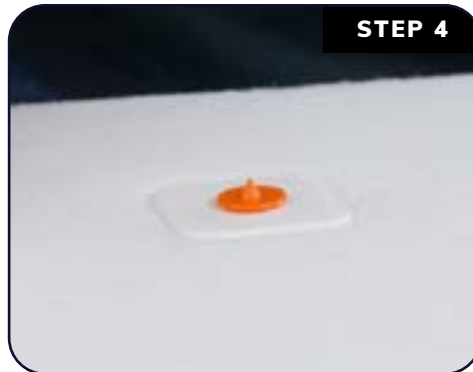

Insert reusable marking plugs into the Snap-On anchors.



Push panel against wall to mark anchor locations.

Revised: 2025-08-12

# AlphaSorb® Polyester Core Acoustic Panel

## Z-Clips

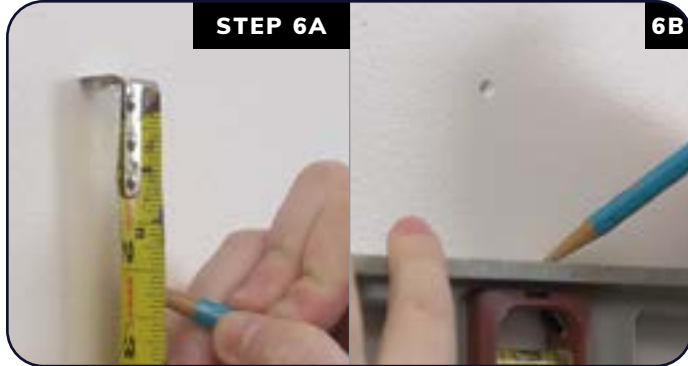

Measure down 2" from each mark. Use a level to make a short line at this location.

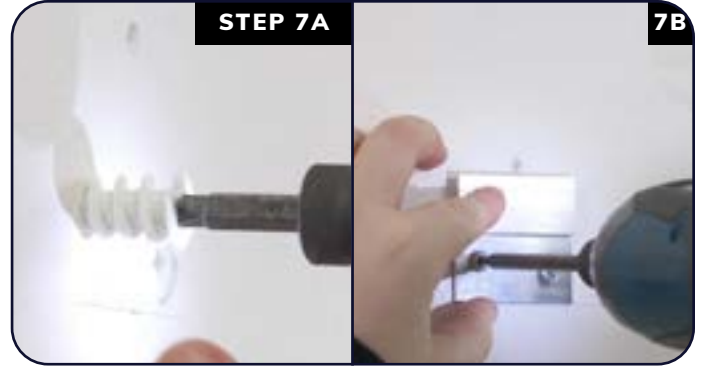

Install each Z-Clip at these locations with the bottom of the clip lined up with the line you made.



Line up the panel. Slide down until you feel the flange contact the top of the Z-Clip, Push in on the panel and slide it down to engage the Z-Clips. Make sure all clips are engaged to complete installation.

Revised: 2025-08-12